

Date rev. Description

V 1.0

House	34.12381	Sheet	1
-------	----------	-------	---

Drawing	3D	Scale	
---------	----	-------	--

Material	34x135	Date	21.03.2024
----------	--------	------	------------

Drawer	K.K.	File	34.12381 3D.dwg
--------	------	------	-----------------

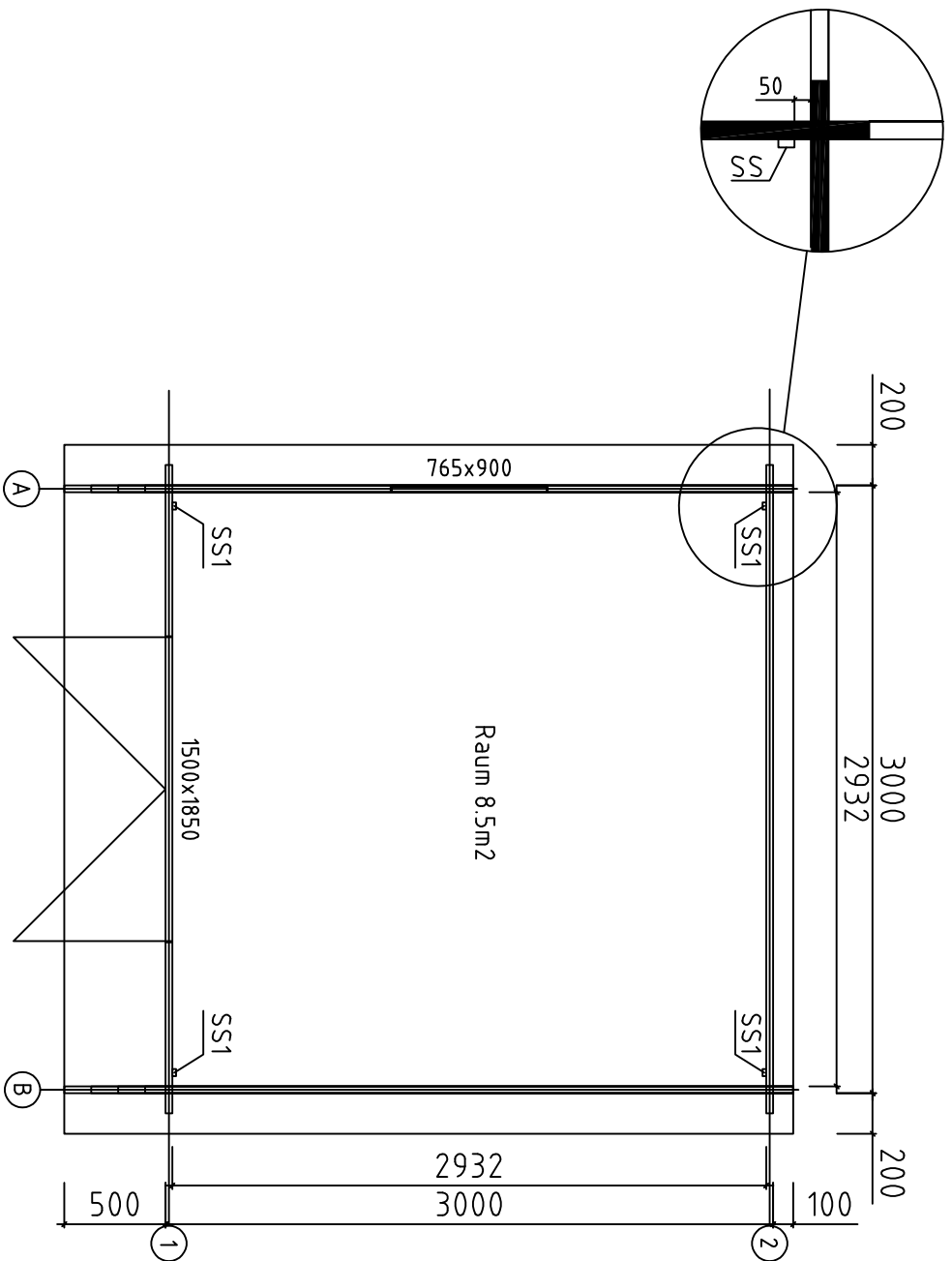

Kood	3412381	Leht	2
Joonis	Plan	Mootkava	1:35
Materjal	34x135	Kuup.	21.03.2024
Joonestaj	K.K.	File	3412381.dwg

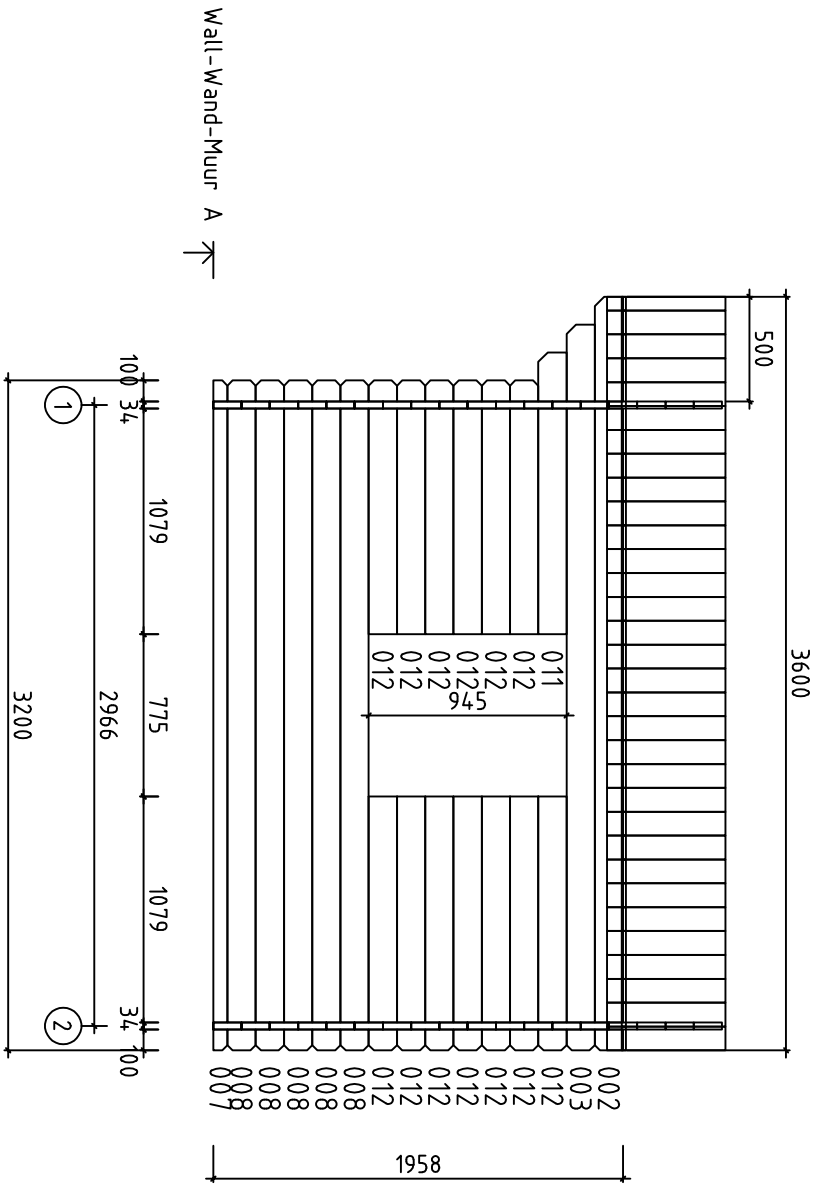



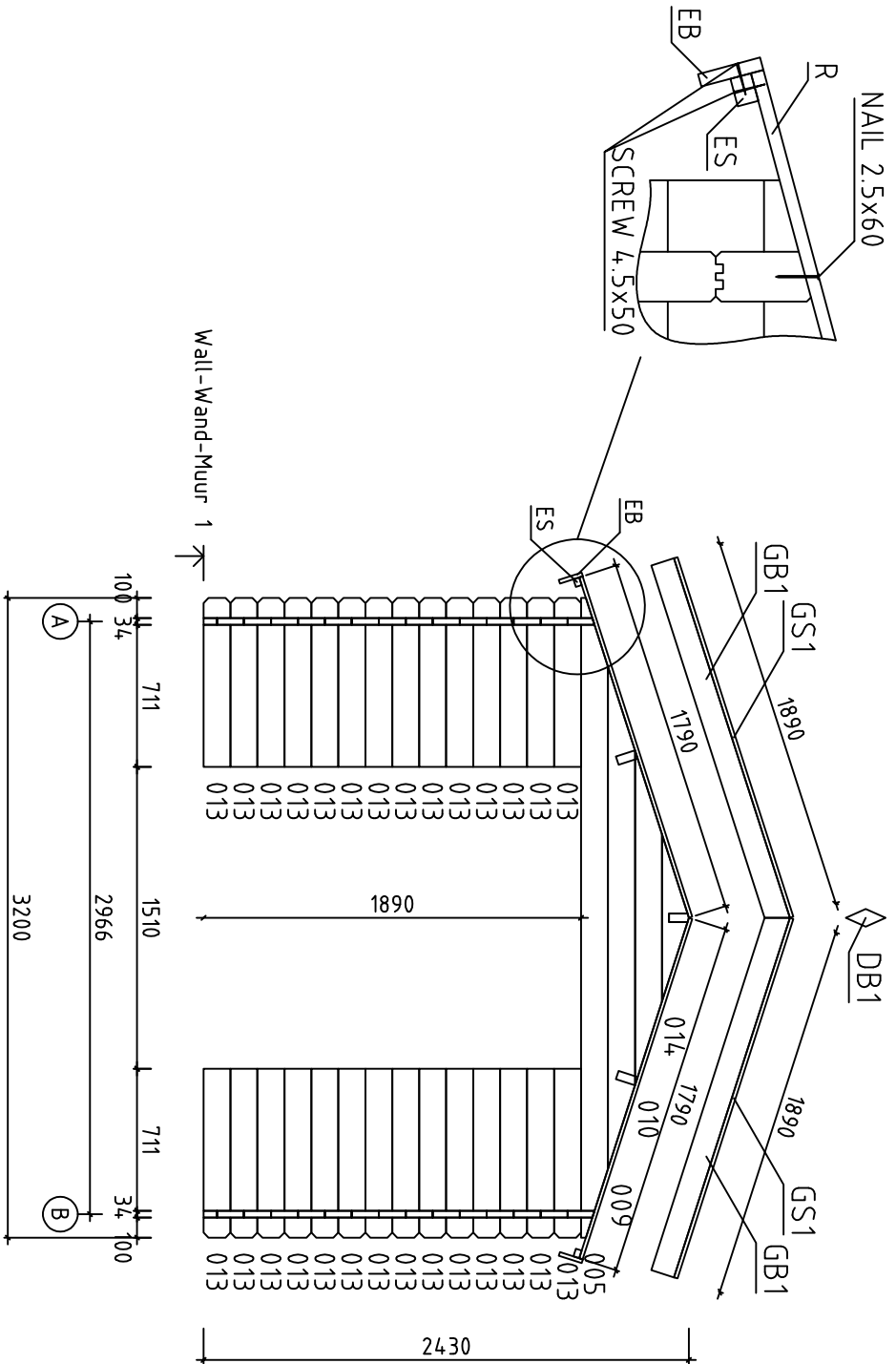



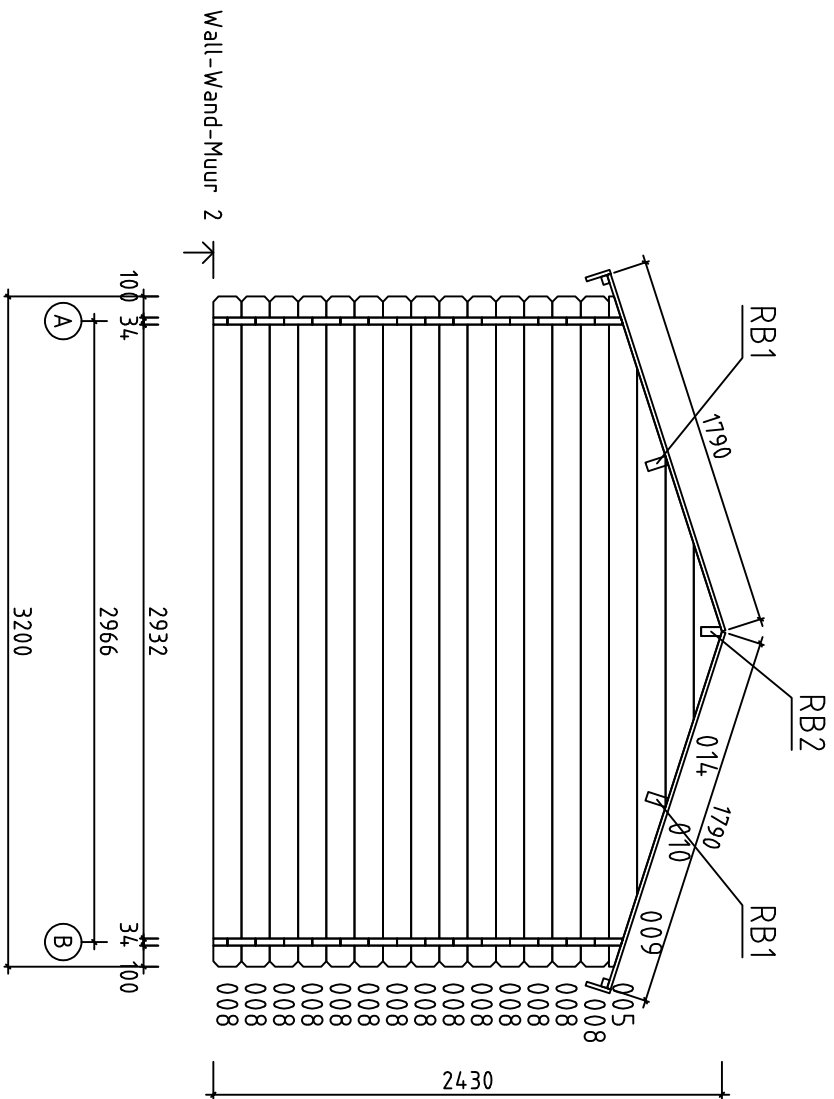

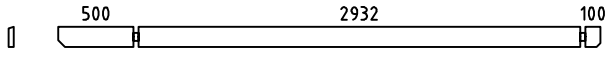
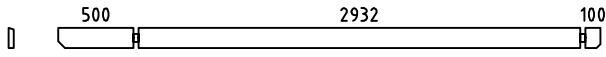
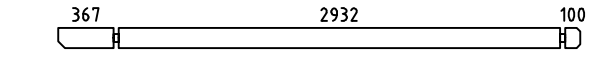
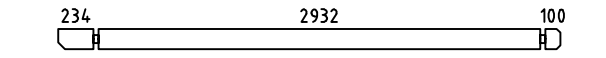
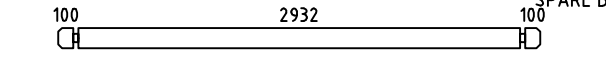
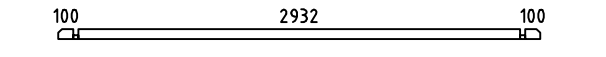
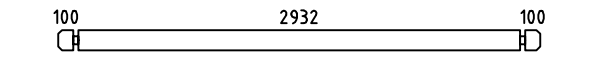
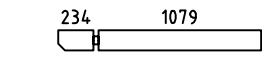
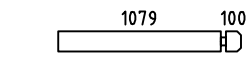
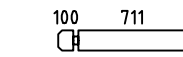
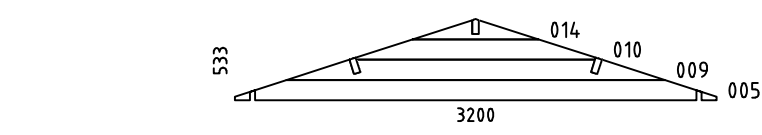
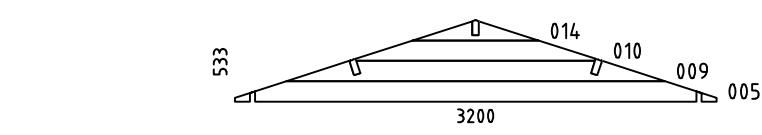

Kood	3412381	Leht	3
Joonis	WALL-WAND-MUUR A	Mohtava	1:35
Materjal	3,4x13,5	Koop	21.03.2024
Jonestas	K.K.	File	3412381.dwg

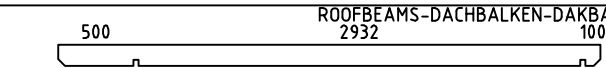
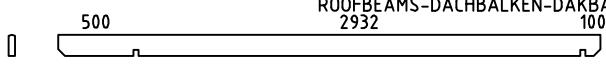

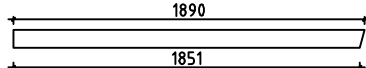

Kood	3412381	Leht	5
Joonis	WALL - WAND - MUUR 1	Mootkava	1:35
Materjal	3.4x13.5	Kuup.	21.03.2024
Joonestaja	K.K.	File	3412381.dwg



Kood	3412381	Leht	6
Joonis	WALL - WAND - MUUR 2	Mootkava	1:35
Materjal	3,4x13,5	Kuup.	21.03.2024
Joonestaja	K.K.	File	3412381.dwg

Pos	Specification-Bestimmung-Omschrijving	Pcs	Profile (mm)	L (mm)		
001		1	34x135	3600		
002		1	34x135	3600		
003		2	34x135	3467		
004		1	34x135	3334		
006	 SPARE BEAM-ERZATZBOHLE-VOORRAADPLANK	1	34x135	3200		
007		2	34x68	3200		
008		30	34x135	3200		
011		1	34x135	1346		
012		13	34x135	1213		
013		28	34x135	845		
W1-1		1	34x533	3200		
W2-1		1	34x533	3200		
HB	HIT BLOCK-SCHLAGHÖLZER-BLAZENPLANK 	2	34x135	300		
RB1	 ROOFBEAMS-DACHBALKEN-DAKBALK	2	43x140	3600		
RB2	 ROOFBEAMS-DACHBALKEN-DAKBALK	1	43x140	3600		
R1	ROOFBOARD-DACHBRETT-DAKPLANK  or-oder-of	84+2 64+2	18x88 18x114	1790		
GB1	GABLE BOARD-GIEBELBLENDE-GEVELPLANK 	4	18x120	1890		
GS1	ROOF FELT FILLET-GIEBELLEISTE-GEVELLIJST 	4	18x70	1890		
EB1	EAVE BOARD-TRAUFBRETT-AFDEKPLANK 	2	18x90	3600		
ES1	EAVE SLAT-TRAUFFENLEISTE-AFDEKLIJST 	2	30x40	3600		
DB1	DIAMOND-RAUTE-DIAMANT 	2	18x90	200		
SS1	STORM SLAT-STURMLEISTE-STORMLIJST 	4	18x35	1900		
	SCREWS-SCHRAUBEN-SCHROEF FOR-FÜR-VOOR SS1 	12	φ6.0	50		
Kood	3412381	Materjal	File	3412381.dwg	Leht	7

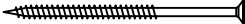
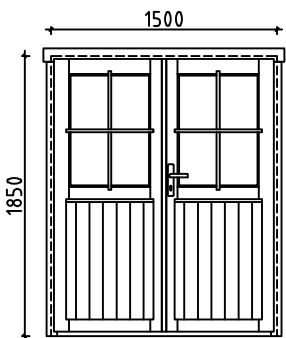
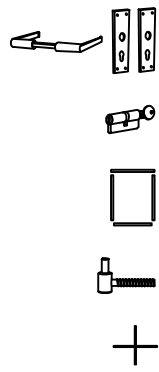
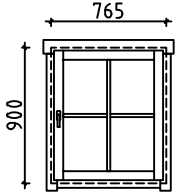
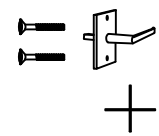
Pos	Specification-Bestimmung-Omschrijving	Pcs	Profile (mm)	L (mm)
	WASHER-SCHEIBE-SCHIJF FOR-FÜR-VOOR SS1 	12	∅6.0	18
	NAIL-NAGEL-NAGEL FOR-FÜR-VOOR R1 	260	∅2.5	60
	SCREWS-SCHRAUBEN-SCHROEF FOR-FÜR-VOOR GB1, GS1, EB1, ES1, DB1 	82	∅4.5	50
	SCREWS-SCHRAUBEN-SCHROEF FOR-FÜR-VOOR RB1, RB2 	6	∅6.0	160
	<p>DOUBLEDOOR-DOPPELTÜR-DUBBELE DEUR (right-rechts-rechts) AST_ISO_PL P</p>   <p>WINDOW-FENSTER-VENSTER (1x right-rechts-rechts) AST_ISO_KP P</p>  	1	1500	1850
Kood	3412381	Materjal	File	3412381.dwg
			Leht	8